

X3 D / TW

EXHIBITION LAMP WITH DAYLIGHT / TUNABLE WHITE LEDS



FEATURES

- ▶ 31 x 15 W Daylight / Tunable White LEDs (6,800 K)
- ▶ High light output: 21,000 lm
- ▶ Low weight: 5.5 / 7.5 kg
- ▶ Selectable pulse width modulation (up to 25 kHz) for flicker-free operation
- ▶ Narrow beam angle of 8° for precise illumination
- ▶ Optional filters for 20°, 50°, 80°, 10° x 60° beam angles
- ▶ Simple configuration via rotary-push encoder and OLED display
- ▶ IP protection class: IP20

DESCRIPTION

Whether at trade fairs, in galleries or museums - when the focus is on the presentation of products, works or exhibits, a flexible spotlight is needed for precise illumination. With the Cameo X3 D / TW, stand builders, lighting designers and technicians get a powerful LED specialist for pinpoint illumination of objects and exhibition areas in the daylight range (6,800 K).

With its 31 x 15W LEDs, the X3 D / TW produces an extremely high light output of 21,000 lumens. This means that the trade fair spotlight can easily assert itself even in brightly lit halls. Equipped with a narrow beam angle of 8°, the X3 D / TW can be precisely aimed at objects. The optionally available barndoor offers additional flexibility and precision. For wider areas, Cameo offers optional filters for beams with 20°, 50°, 80°, 10° x 60° beam angles. In addition, the compact and 5.5 / 7.5 kg light X3 D / TW does not cause space or weight problems in the always overcrowded rigs of exhibition halls & Co. Thanks to the adjustable PWM frequency (650 Hz - 25 kHz), the X3D / TW also enables flicker-free operation.

The Cameo X3 D / TW can be controlled via DMX512 or RDM. On the fixture itself, rotary-push encoders and an LED display provide a convenient basic setup.



Features and specifications
subject to change without notice.

adamhall.com

X3 D / TW

EXHIBITION LAMP WITH DAYLIGHT / TUNABLE WHITE LEDS



PHOTOMETRICAL DATA

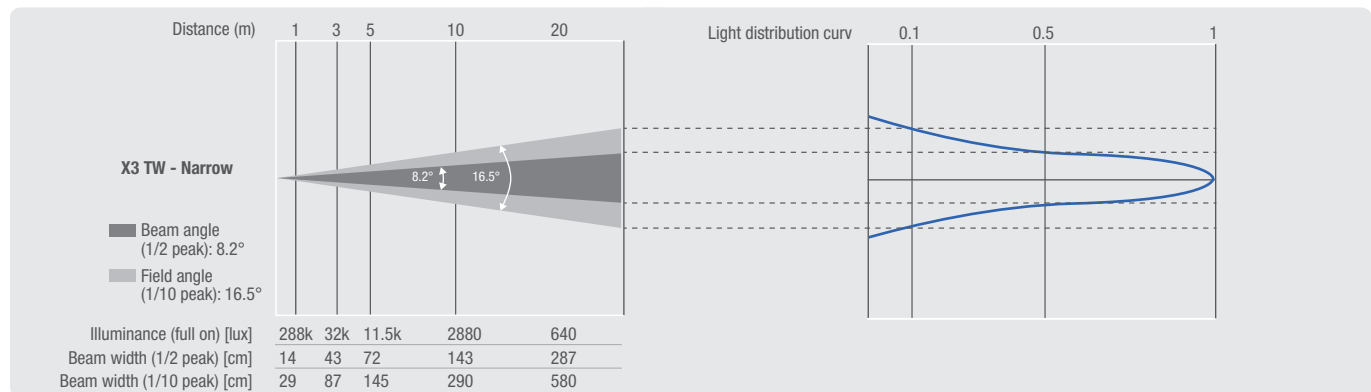
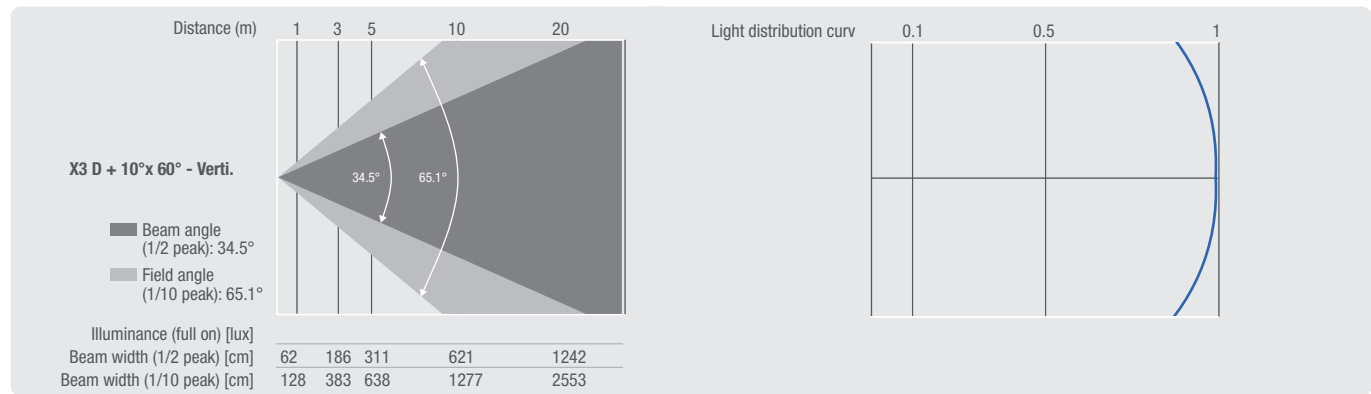
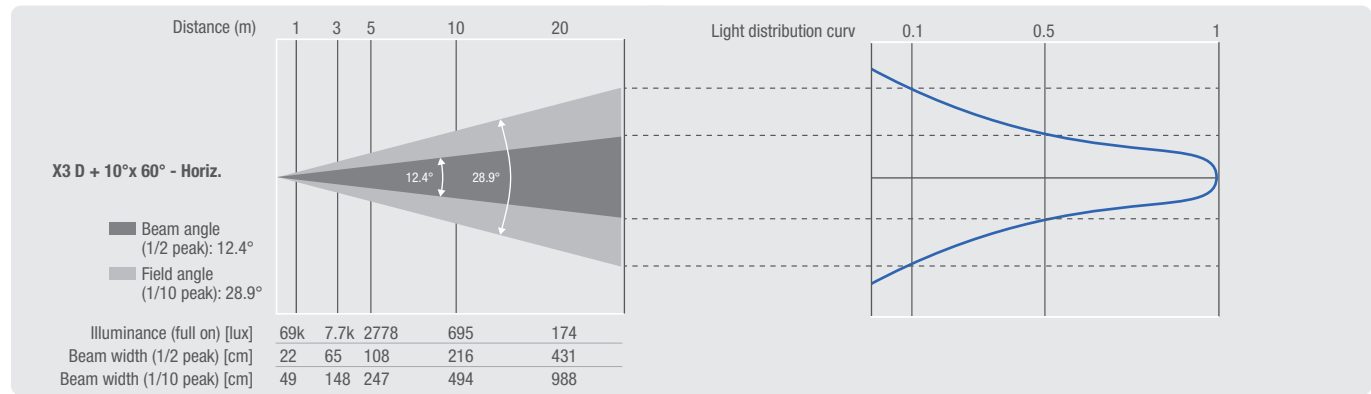
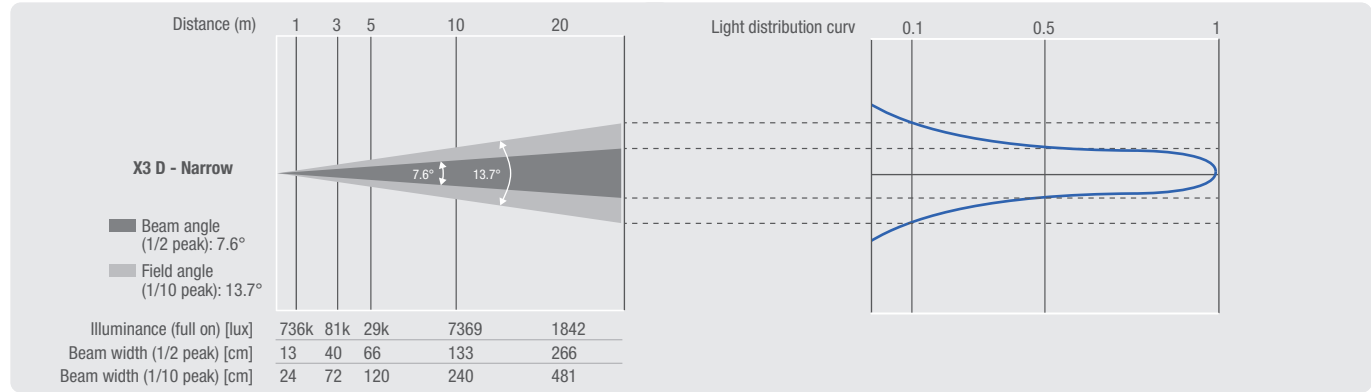

Features and specifications
subject to change without notice.

adamhall.com

X3 D / TW

EXHIBITION LAMP WITH DAYLIGHT / TUNABLE WHITE LEDS



PHOTOMETRICAL DATA

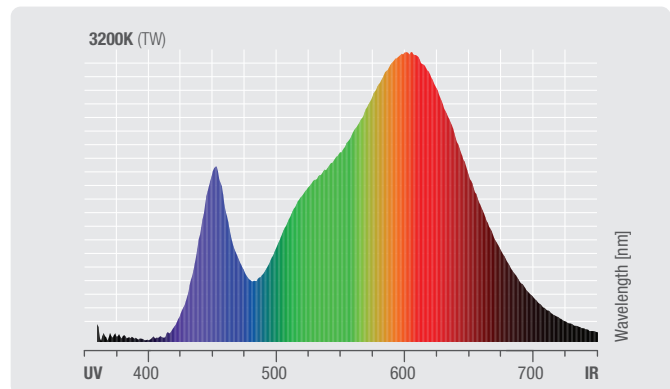
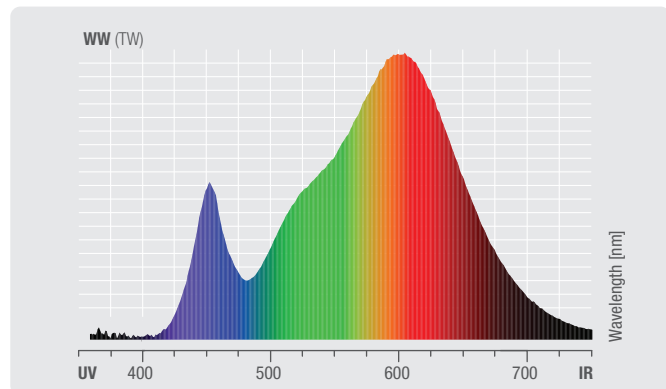
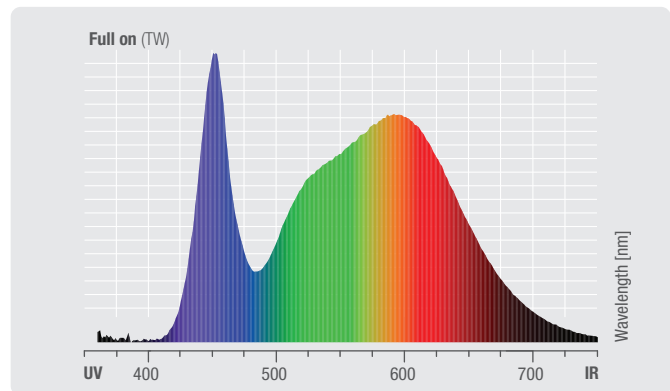
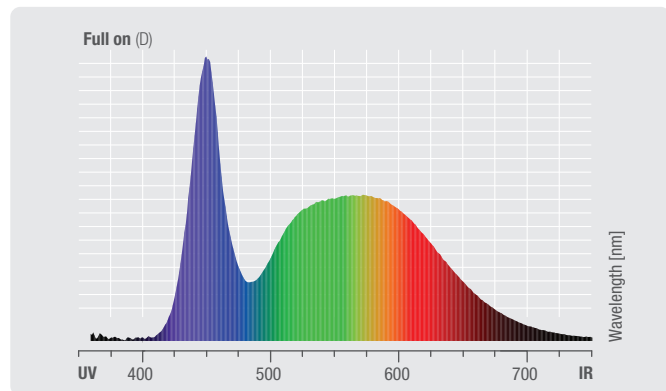
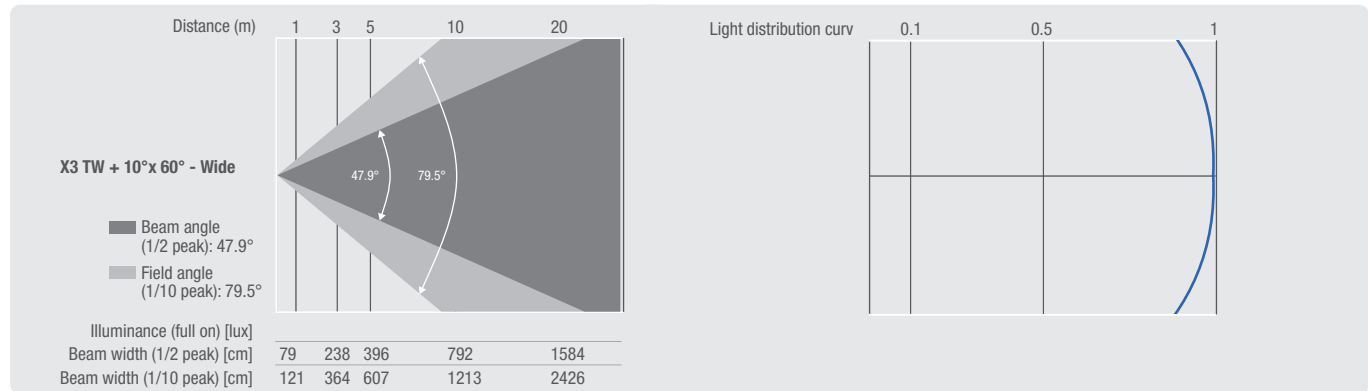
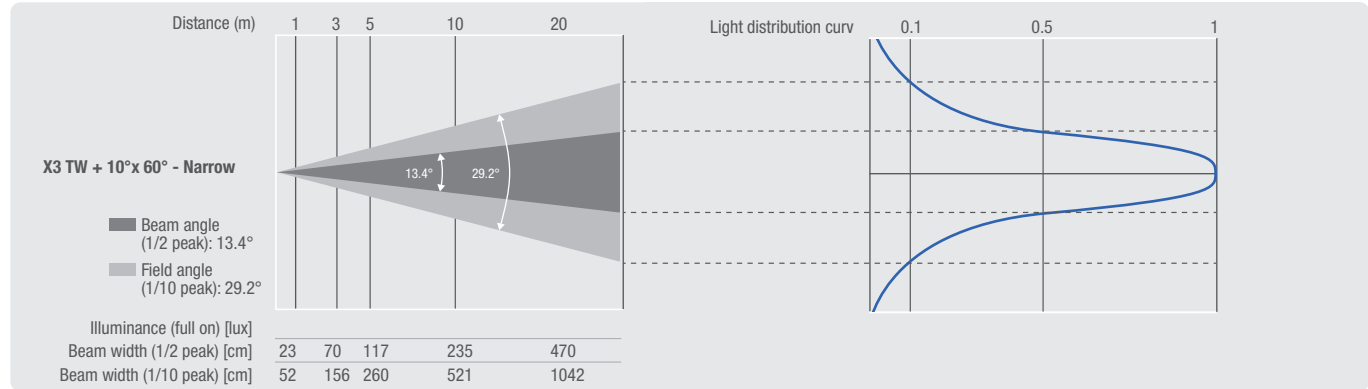

Features and specifications subject to change without notice.

adamhall.com

X3 D / TW

EXHIBITION LAMP WITH DAYLIGHT / TUNABLE WHITE LEDS



PHOTOMETRICAL DATA

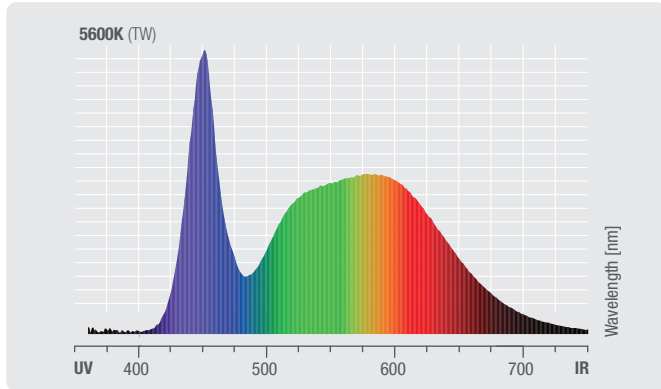

	Luminous flux	Chromaticity coordinates	CCT	R _s
White (D)	23000 lm	x 0.310 y 0.311	6800K	83
White (TW)	12000 lm	x 0.311 y 0.313	6800K	83
Warm White (TW)	9700 lm	x 0.421 y 0.394	3200K	82
Full on (TW)	21000 lm	x 0.355 y 0.346	4600K	84
3200K (TW)		x 0.421 y 0.394	3200K	83
5600K (TW)		x 0.339 y 0.335	5600K	84

SPECIFICATIONS

Product type	LED PAR Lighting
Type	Exhibition Lamp
Colour rendering index (CRI)	83 Ra
Number of LEDs	31
LED type	15 W
Refresh rate	650 - 25000 Hz
DMX input	XLR 5-pin malez
DMX output	XLR 5-pin female
DMX Functions	Device Settings, Dimmer, strobe
Standalone modes	Auto programs, Static, Timer
Controls	Push encoder
Indicators	OLED Display
Operating voltage	100 V AC - 240 V AC, 50 - 60 Hz
Power connector	TRUE1 Compatible Power I/O Socket
Housing material	Metal
Cabinet colour	Black
Protection class IP	IP20
Cooling	temperature-controlled fan
Color temperature	6800 K
Ambient temperature (operating)	0 - 40 °C
Weight	5.5 kg
Accessories (included)	Power supply

DIMENSIONS (mm)

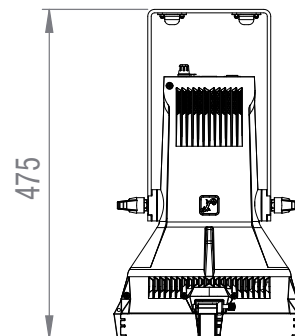
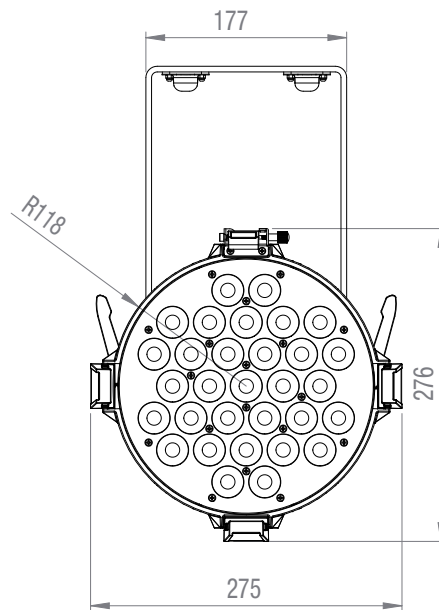

Features and specifications subject to change without notice.

adamhall.com

X3 D / TW

EXHIBITION LAMP WITH DAYLIGHT / TUNABLE WHITE LEDS



DIMENSIONS (mm)

