

PIXBAR® 400 IP G2

IP65 RGBW LED BAR



FEATURES

- ▶ Simple and efficient interconnection of up to 3 units with the optional STACK-KIT
- ▶ Adjustable feet for truss-bracing positioning
- ▶ Optional VERTI-MOUNT for standing or hanging application
- ▶ Easy slide-in filter mechanism with locking mechanism
- ▶ Fanless cooling design
- ▶ High brightness and accurate colour mixing
- ▶ SPIN16® included

DESCRIPTION

Introducing the second generation of Cameo PIXBAR®-Series. With its sophisticated features and durable design, it is the ideal lighting option for any event, whether it is held indoors or outdoors. The PIXBAR® G2 models 400 IP or 600 IP are equipped with RGBW or RGBAWuV LEDs, IP65 certification, and well-thought-out accessories.

Whether hanging or standing, the optional connection system allows for a variety of creative designs and placement options creating unique lighting effects and set designs. Up to three units can be connected vertically with the optional VERTI MOUNT and STACK KIT for a seamless and synchronized lighting effect. With the M20 adapter the new PIXBAR®-Series can be mounted on M20 threaded base plates. Truss mounting is also made easier thanks to the adjustable feet. All filters can be inserted quickly and easily using the slide-in mechanism of the filter rail.

Additionally, the IP65 LED bars operate quietly thanks to the fanless cooling system, while still ensuring a strong light output. SPIN16® adaptors are also included with each device. So, what are you waiting for? Upgrade your lighting game with Generation 2 of the PIXBAR®-Series.



PIXBAR® 400 IP G2

IP65 RGBW LED BAR



PHOTOMETRICAL DATA

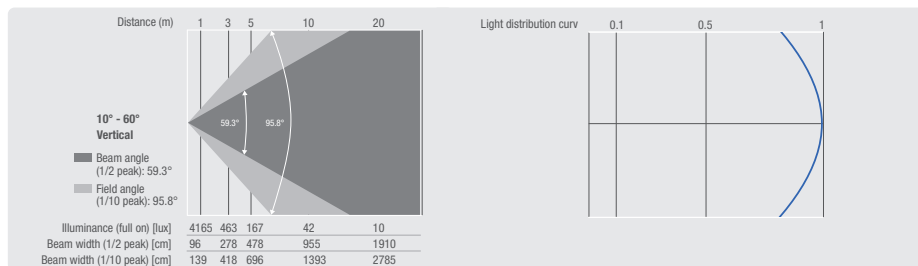
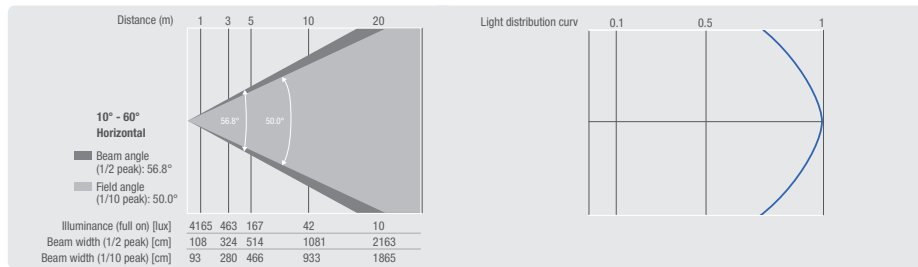
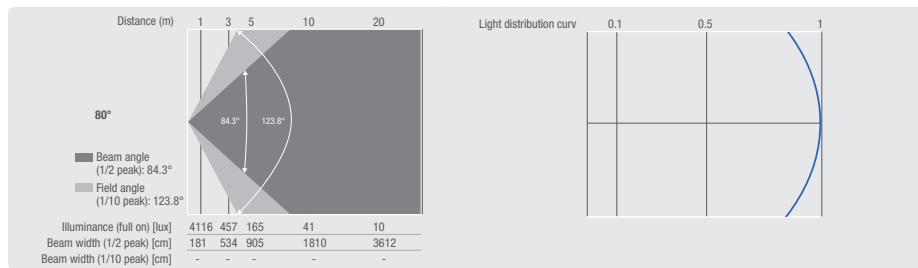
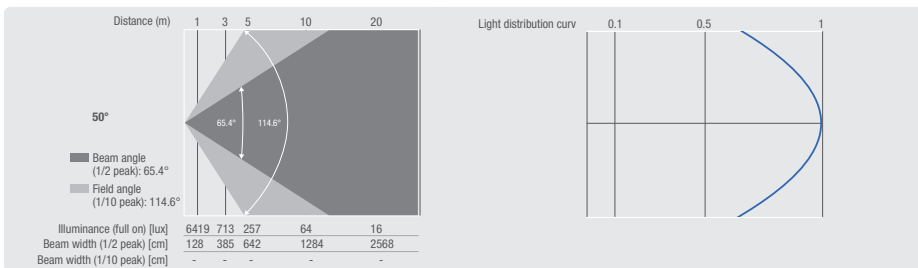
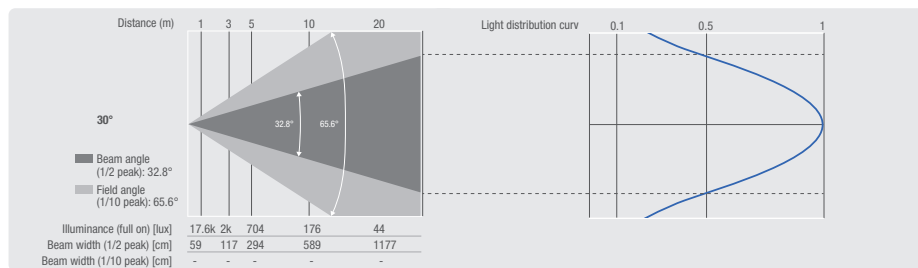
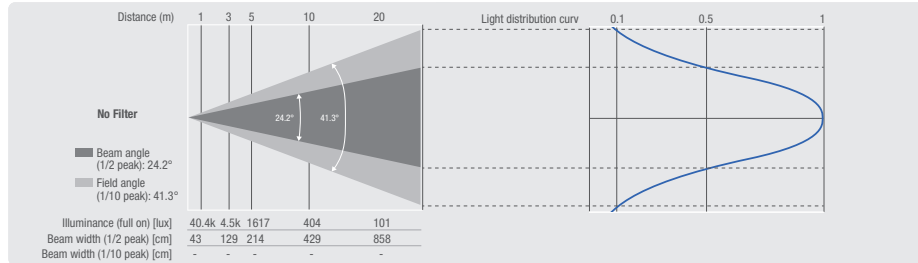

	Luminous flux	Chromaticity coordinates	CCT	R _a
Full on	6480 lm	x 0.240 y 0.236	2.3K - 8.6K	84
Red (calibrated)	1336 lm	x 0.662 y 0.295	-	-
Green (calibrated)	2868 lm	x 0.172 y 0.630	-	-
Blue (calibrated)	448 lm	x 0.160 y 0.033	-	-
White (calibrated)	6412 lm	x 0.286 y 0.329	-	-
3200K (calibrated)	4848 lm	x 0.409 y 0.399	-	-
5600K (calibrated)	4364 lm	x 0.321 y 0.332	-	-

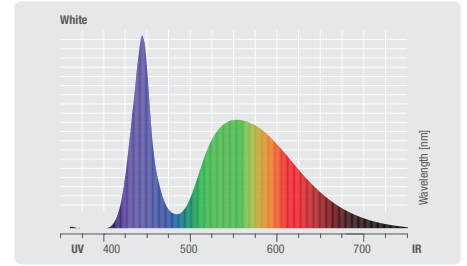
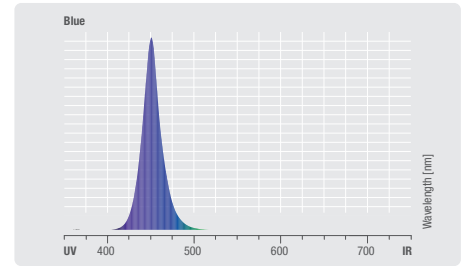
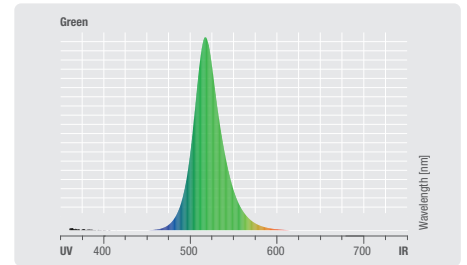
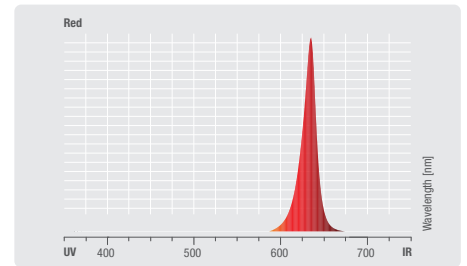
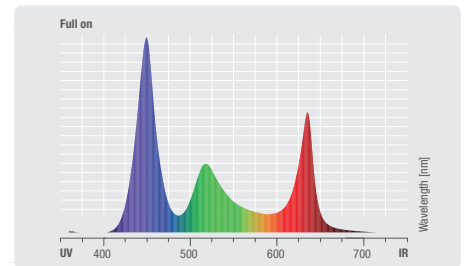

Features and specifications subject to change without notice.

adamhall.com

PIXBAR® 400 IP G2

IP65 RGBW LED BAR



SPECIFICATIONS

Product type	LED Bars
Type	IP65
Colour spectrum	RGBW
Luminous flux (lm)	6500 lm @ 6300 K; R: 2500 lm; G: 3600 lm; B: 570 lm; W: 5000 lm
Number of LEDs	16
LED type	4-in-1 LED
Lens	30 mm acrylic lens
Refresh rate	650 Hz, 1530 Hz, 3600 Hz, 12000 Hz, 18900 Hz, 25000 Hz
Dimmer resolution	16 bit, 8 bit
Dimmer curves	Exponential, Linear, Logarithmic, S curve
Strobe	0 - 20 Hz
Color temperature	2200 - 8000 K
Colour rendering index (CRI)	>84 Ra @ 5600K
Dispersion	Beam Angle: 25 °, Field Angle: 42 °
Protocols	DMX, EZ-Remote, Master / Slave mode, RDM, Standalone, Wireless
DMX input	Wireless DMX, XLR 5-pin male IP65
DMX output	Wireless DMX, XLR 5-pin female IP65
DMX mode	10-channel, 16-channel, 1-channel, 36-channel, 37-channel, 3-channel, 48-channel, 4-channel, 64-channel, 68-channel, 7-channel, D2-channel, D4-channel, D7-channel
DMX Functions	Background Colour Macro, Background Colour Macro Crossfade, Background Colour Temperature, Background Dimmer, Background Dimmer Fine, Background RGBWA, Background RGBWA Fine, Background Strobe, Background Tint, Background UV, Background UV Fine, Colour presets, Colour presets Crossfade, Colour temperature, Device Settings, Dimmer, Dimmer Fine, DMX Delay (EZ-Chase), Grouping, Pattern Speed, Pattern Transition, Patterns, RGBWA + UV, RGBWA + UV Fine, Running Effect Pattern, Selection Folder, Strobe, Tint
Standalone modes	Auto programs, Colour presets, Loop, slave mode, Static
System settings	Auto Lock, Colour calibration, Dimmer Curve, Dimmer Response, Display Off Timer, Display Reverse, Load Default, PWM, Service, Signal Fail, Store Default, Wireless
Controls	4 buttons, Display
Indicators	2-row display
Protection class IP	IP65
Ambient temperature (operating)	-10 - 40 °C
Cooling	Passive convection, fanless
Operating voltage	100 V AC - 240 V AC, 50 - 60 Hz
Max current	0.77 A @ 230 V, 1.62 A @ 110 V
Inrush Current Power	42 A
Max. power consumption	180 W @ 230 V / 110 V
Standby power consumption	9 W
Housing material	Die-cast aluminium
Cabinet colour	Black
Width	1018 mm
Height	205 mm
Depth	162 mm
Weight	11.8 kg

DIMENSIONS (mm)

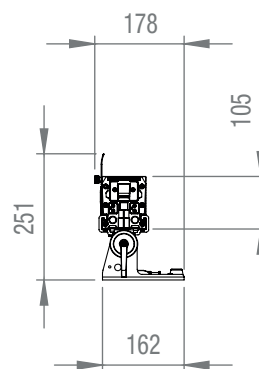
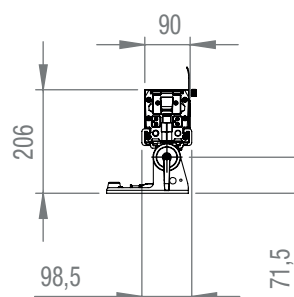
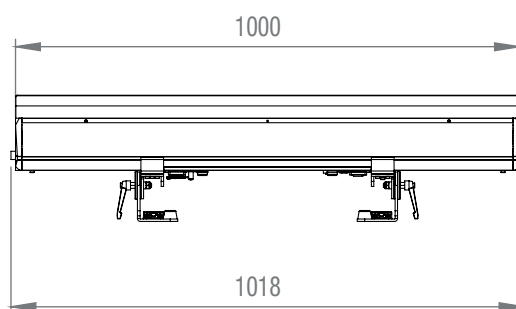
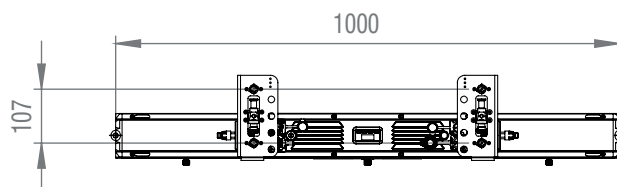

Features and specifications subject to change without notice.

adamhall.com